

20MHz to 134MHz Spread-Spectrum Clock Modulator for LCD Panels

General Description

The DS1181L is a spread-spectrum clock modulator IC that reduces EMI in high clock-frequency-based, digital electronic equipment.

Using an integrated phase-locked loop (PLL), the DS1181L accepts an input clock signal in the range of 20MHz to 134MHz and delivers a spread-spectrum modulated output clock signal. The PLL modulates, or dithers, the output clock about the center input frequency at a pin-selectable magnitude, allowing direct EMI control and optimization. In addition, through an enable pin the dithering can be enabled or disabled for easy comparison of system performance during EMI testing. This same input pin also allows the DS1181L output to be three-stated.

By dithering the system clock, all the address, data, and timing signals generated from this signal are also dithered so that the measured EMI at the fundamental and harmonic frequencies is greatly reduced. This is accomplished without changing clock rise/fall times or adding the space, weight, design time, and cost associated with mechanical shielding.

The DS1181L is provided in an 8-pin TSSOP package and operates over a full automotive temperature range of -40°C to +125°C.

Applications

LCD Panels for TVs, Desktop Monitors, and Notebook and Tablet PCs

Automotive Telematics and Infotainment

Printers

Typical Operating Circuit appears at end of data sheet.

Block Diagram

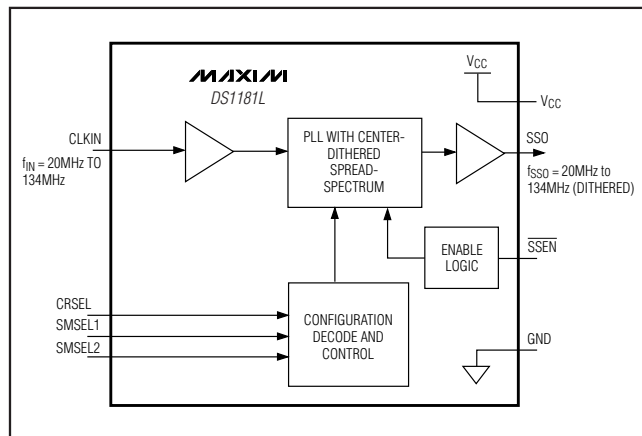

Features

- ◆ Modulates a 20MHz to 134MHz Clock with Center Spread-Spectrum Dithering
- ◆ Selectable Spread-Spectrum Modulation Magnitudes of:
 - ±0.5%
 - ±1.0%
 - ±1.5%
 - ±2.0%
- ◆ Low 75ps Cycle-to-Cycle Jitter
- ◆ Spread-Spectrum Disable Mode
- ◆ Pin Compatible with Alliance/PulseCore Semiconductor P2040 Series Devices
- ◆ Clock Output Disable
- ◆ Low Cost
- ◆ Low Power Consumption
- ◆ 3.3V Single Voltage Supply
- ◆ -40°C to +125°C Temperature Range
- ◆ Small 8-Pin TSSOP Package

Ordering Information

PART	TEMP RANGE	PIN-PACKAGE
DS1181LE+	-40°C to +125°C	8 TSSOP
DS1181LE+T	-40°C to +125°C	8 TSSOP

+ Denotes a lead-free package.

T = Tape and reel.

Pin Configuration

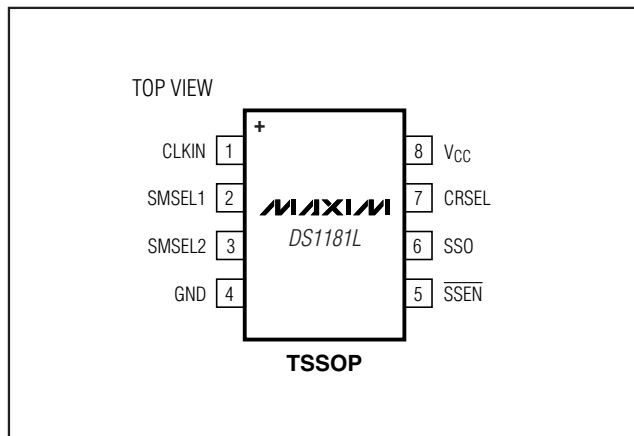

20MHz to 134MHz Spread-Spectrum Clock Modulator for LCD Panels

ABSOLUTE MAXIMUM RATINGS

Voltage Range on V_{CC} Relative to GND-0.5V to +3.63V
 Voltage Range on Any Lead Relative to GND-0.5V to ($V_{CC} + 0.5V$), not to exceed +3.63V
 Operating Temperature Range-40°C to +125°C

Storage Temperature Range-55°C to +125°C
 Soldering Temperature.....See J-STD-020 Specification

Stresses beyond those listed under "Absolute Maximum Ratings" may cause permanent damage to the device. These are stress ratings only, and functional operation of the device at these or any other conditions beyond those indicated in the operational sections of the specifications is not implied. Exposure to absolute maximum rating conditions for extended periods may affect device reliability.

RECOMMENDED OPERATING CONDITIONS

($T_A = -40^\circ\text{C}$ to $+125^\circ\text{C}$, unless otherwise noted.)

PARAMETER	SYMBOL	CONDITIONS	MIN	TYP	MAX	UNITS
Supply Voltage	V_{CC}	(Note 1)	3.0		3.6	V
Input Logic 1	V_{IH}		$0.8 \times V_{CC}$		$V_{CC} + 0.3$	V
Input Logic 0	V_{IL}		-0.3		$0.2 \times V_{CC}$	V
Input Logic Float (\overline{SSEN} , CRSEL)	I_{FLOAT}	$0V < V_{IN} < V_{CC}$			± 1	μA
SSO Load	C_L	$SSO < 80\text{MHz}$			15	pF
		$80\text{MHz} \leq SSO < 134\text{MHz}$			7	
CLKIN Frequency	f_{IN}		20		134	MHz
CLKIN Duty Cycle	f_{INDC}		40		60	%

DC ELECTRICAL CHARACTERISTICS

($V_{CC} = +3.0V$ to $+3.6V$, $T_A = -40^\circ\text{C}$ to $+125^\circ\text{C}$, unless otherwise noted.)

PARAMETER	SYMBOL	CONDITIONS	MIN	TYP	MAX	UNITS
Supply Current	I_{CC}	$C_L = 7\text{pF}$, $f_{IN} = 134\text{MHz}$			18	mA
SMSEL1/SMSEL2/CLKIN Input Leakage	$I_{IL:1}$	$0V < V_{IN} < V_{CC}$	-1		+1	μA
CRSEL/ \overline{SSEN} Input Leakage	$I_{IL:2}$	$0V < V_{IN} < V_{CC}$	-100		+100	μA
Output Leakage (SSO)	I_{OZ}	$\overline{SSEN} = \text{float}$	-1		+1	μA
Low-Level Output Voltage (SSO)	V_{OL}	$I_{OL} = 4\text{mA}$			0.4	V
High-Level Output Voltage (SSO)	V_{OH}	$I_{OH} = -4\text{mA}$	2.4			V

AC ELECTRICAL CHARACTERISTICS

($V_{CC} = +3.0V$ to $+3.6V$, $T_A = -40^\circ\text{C}$ to $+125^\circ\text{C}$, unless otherwise noted.)

PARAMETER	SYMBOL	CONDITIONS	MIN	TYP	MAX	UNITS
SSO Duty Cycle	f_{SSODC}	Measured at $V_{CC}/2$	40		60	%
SSO Rise Time	t_R	$C_L = 7\text{pF}$		1		ns
SSO Fall Time	t_F	$C_L = 7\text{pF}$		1		ns
Peak Cycle-to-Cycle Jitter	t_J	$T_A = -40^\circ\text{C}$ to $+85^\circ\text{C}$, 10,000 cycles		75		ps
Power-Up Time	t_{POR}	(Note 2)			50	ms

Note 1: All voltages referenced to ground. Currents into the IC are positive and out of the IC are negative.

Note 2: Time between power applied to device and stable output.

20MHz to 134MHz Spread-Spectrum Clock Modulator for LCD Panels

Typical Operating Characteristics

($T_A = +25^\circ\text{C}$, unless otherwise noted.)

DS1181L

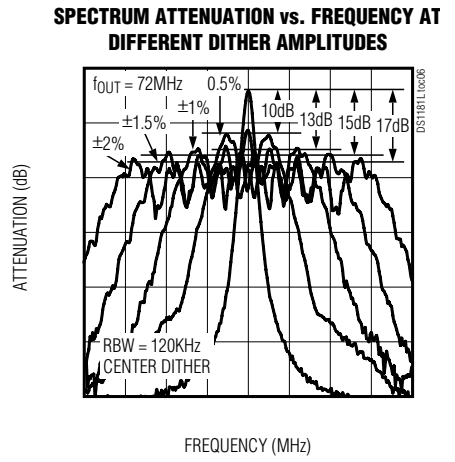
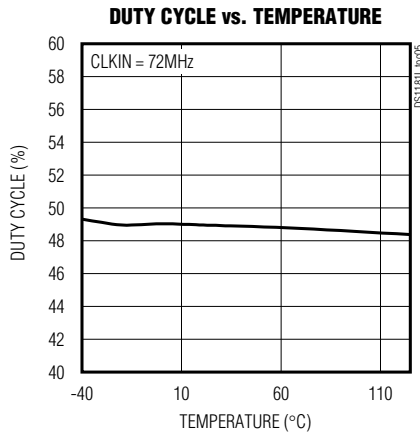
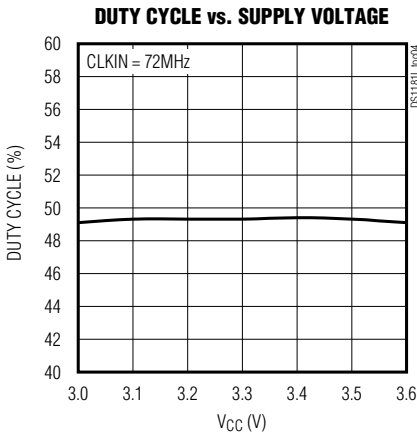
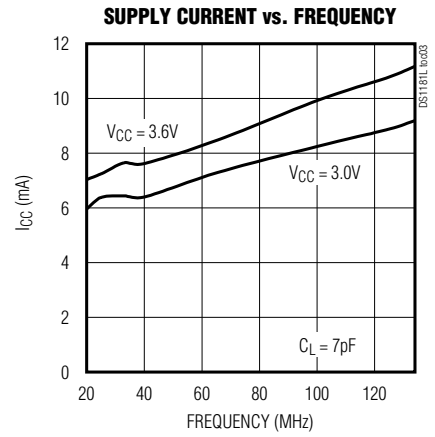
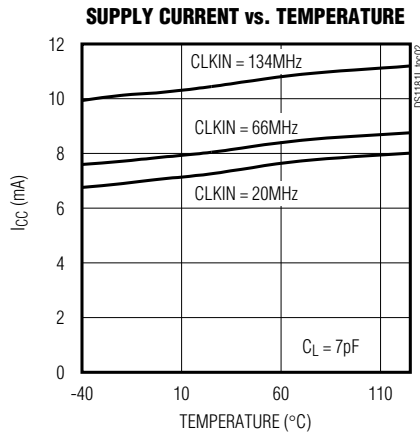
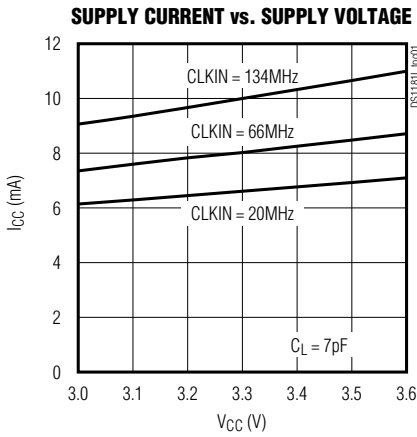

20MHz to 134MHz Spread-Spectrum Clock Modulator for LCD Panels

Pin Description

PIN	NAME	FUNCTION													
1	CLKIN	Clock Input. 20MHz to 134MHz clock input (f_{IN}).													
2	SMSEL1	Spread-Spectrum Magnitude Select Inputs. These digital inputs select the desired spread-spectrum magnitude as shown in the table below.													
		<table border="1"> <thead> <tr> <th>SMSEL2</th> <th>SMSEL1</th> <th>MAGNITUDE SELECTED (%)</th> </tr> </thead> <tbody> <tr> <td>0</td> <td>0</td> <td>± 2.0</td> </tr> <tr> <td>0</td> <td>1</td> <td>± 1.5</td> </tr> <tr> <td>1</td> <td>0</td> <td>± 1.0</td> </tr> <tr> <td>1</td> <td>1</td> <td>± 0.5</td> </tr> </tbody> </table>	SMSEL2	SMSEL1	MAGNITUDE SELECTED (%)	0	0	± 2.0	0	1	± 1.5	1	0	± 1.0	1
SMSEL2	SMSEL1	MAGNITUDE SELECTED (%)													
0	0	± 2.0													
0	1	± 1.5													
1	0	± 1.0													
1	1	± 0.5													
3	SMSEL2														
4	GND	Ground													
5	$\overline{\text{SSEN}}$	Spread-Spectrum Enable. Three-level input to enable/disable spread-spectrum and to three-state the output. 0 = Power-up/spread-spectrum enabled. Float = SSO three-stated. 1 = Power-up/spread-spectrum disabled (not a bypass mode).													
6	SSO	Spread-Spectrum Clock Output. Outputs a center-dithered spread-spectrum version of the clock input at CLKIN.													
7	CRSEL	Clock Range and Dither Rate Select. Three-level input that determines the dither rate. See the <i>Detailed Description</i> section for details.													
		<table border="1"> <thead> <tr> <th>CRSEL</th> <th>CLKIN RANGE (MHz)</th> <th>DITHER RATE</th> </tr> </thead> <tbody> <tr> <td>0</td> <td>66 to 134</td> <td rowspan="3">$f_{IN}/832$</td> </tr> <tr> <td>Float</td> <td>33 to 80</td> </tr> <tr> <td>1</td> <td>20 to 38</td> </tr> </tbody> </table>	CRSEL	CLKIN RANGE (MHz)	DITHER RATE	0	66 to 134	$f_{IN}/832$	Float	33 to 80	1	20 to 38			
		CRSEL	CLKIN RANGE (MHz)	DITHER RATE											
		0	66 to 134	$f_{IN}/832$											
Float	33 to 80														
1	20 to 38														
8	V _{CC}	Supply Voltage													

Detailed Description

The DS1181L modulates an input clock to generate a center-dithered spread-spectrum output. A 20MHz to 134MHz clock is applied to the CLKIN pin. An internal PLL dithers the output clock about its center frequency at a user-selectable magnitude.

Spread-Spectrum Dither Magnitude

The DS1181L can generate dither magnitudes up to $\pm 2\%$. The desired magnitude is selected using input pins SMSEL1 and SMSEL2 as shown in Table 1.

Table 1. Dither Magnitude

SMSEL2	SMSEL1	MAGNITUDE SELECTED (%)
0	0	± 2.0
0	1	± 1.5
1	0	± 1.0
1	1	± 0.5

Spread-Spectrum Dither Rate

The output spread-spectrum dither rate is fixed at $f_{IN}/832$.

Table 2. Dither Rate

CRSEL	CLKIN RANGE (MHz)	DITHER RATE
0	66 to 134	$f_{IN}/832$
Float	33 to 80	
1	20 to 38	

20MHz to 134MHz Spread-Spectrum Clock Modulator for LCD Panels

DS1181L

Spread-Spectrum Enable

On power-up, the output clock (SSO) remains three-stated until the internal PLL reaches a stable frequency. The $\overline{\text{SSEN}}$ input can be used to disable the spread-spectrum modulation and to three-state the SSO output. If the $\overline{\text{SSEN}}$ pin is pulled high, the spread-spectrum modulation is turned off, but the device still uses the internal PLL to generate the clock signal at SSO. If the $\overline{\text{SSEN}}$ pin is floated, the output is three-stated.

Application Information

Power-Supply Decoupling

To achieve best results, it is highly recommended that a decoupling capacitor is used on the IC power-supply pins. Typical values of decoupling capacitors are 0.01 μF and 0.1 μF . Use a high-quality, ceramic, surface-mount capacitor, and mount it as close as possible to the V_{CC} and GND pins of the IC to minimize lead inductance.

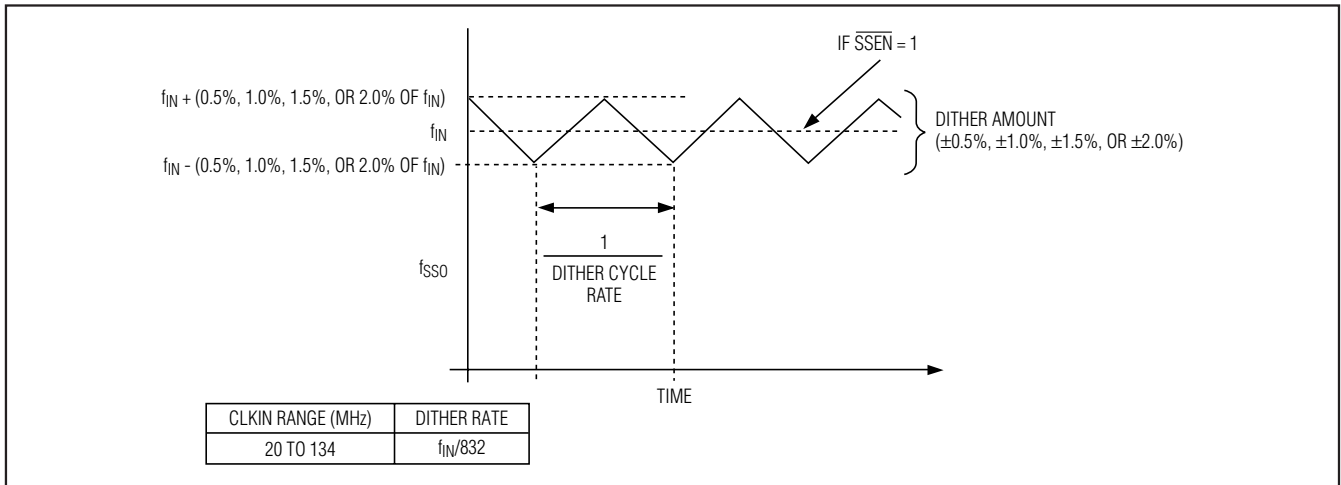
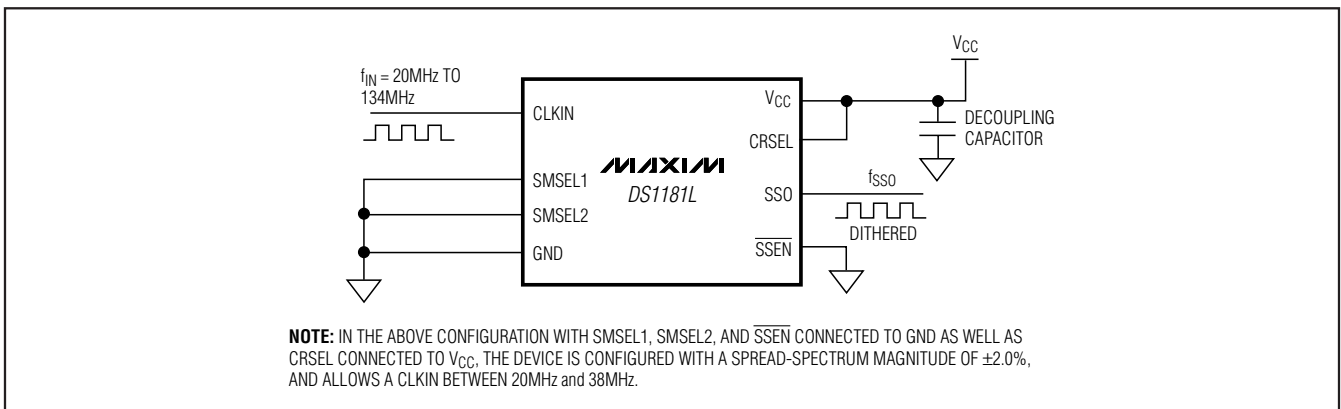

Figure 1. DS1181L Spread-Spectrum Frequency Modulation

Typical Operating Circuit



Package Information

(For the latest package outline information, go to www.maxim-ic.com/DallasPackInfo.)

PACKAGE TYPE	DOCUMENT NO.
8 TSSOP	56-G2021-000

Maxim cannot assume responsibility for use of any circuitry other than circuitry entirely embodied in a Maxim product. No circuit patent licenses are implied. Maxim reserves the right to change the circuitry and specifications without notice at any time.

Maxim Integrated Products, 120 San Gabriel Drive, Sunnyvale, CA 94086 408-737-7600 5